

Article number: 2072166M1215LB

Description: E+G indexing plunger
GN 721.5-6-M12x1,5-LB

Measures

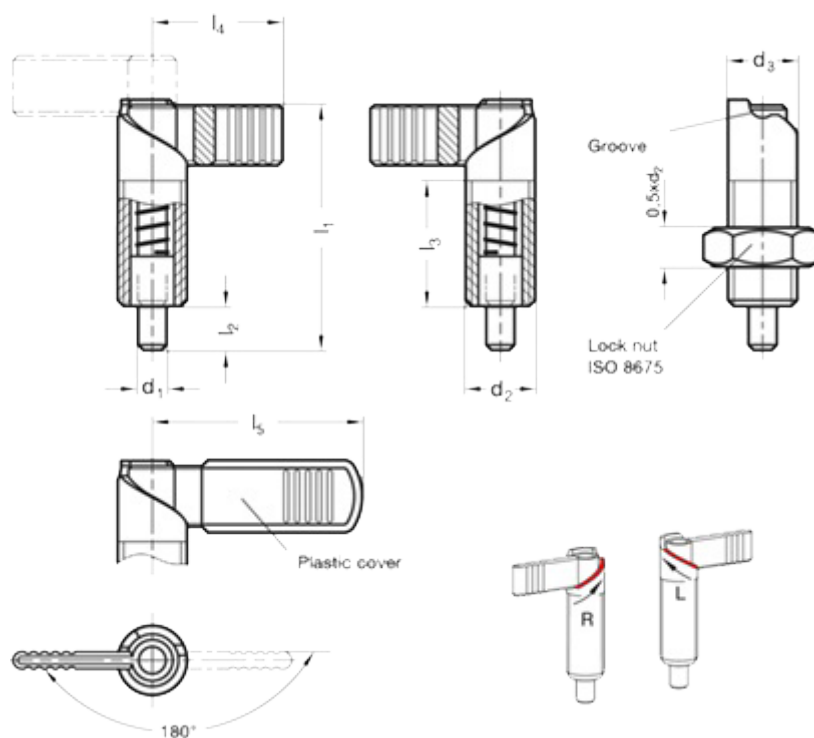

d1 = 6
d2 = M12x1.5
d3 = 12
l1 = 47
l2 = 8
l3 = 26
l4 = 26
l5 = 32

Spring load in N end = 8
Spring load in N top = 18
Weight in (g) = 155